

Ø8X25mm

A
8x



M8 mm

B
8x



3.5x5mm

C
48x



4 x 30mm

D
4x



8 x 45mm

E
8x



8 x 60mm

F
4x



Ø6mm

G
8x



6 x 50mm

H
8x

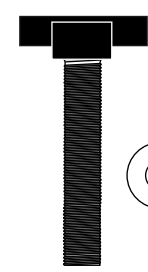

I
6x



W 8mm

J
12x



8 x 50mm

K
2x

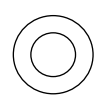

Ø8mm

L
30x



N
8x

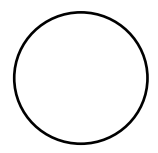

O
3x



P
11x

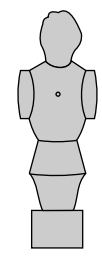

Q
11x

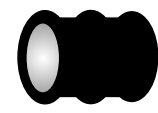

S
8x

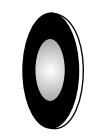

T
8x

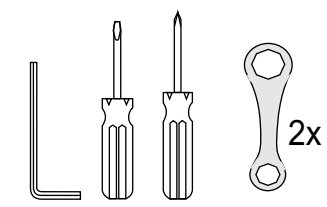

2x

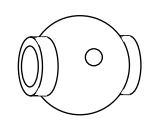

U
2x



V
2x

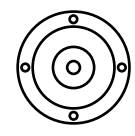

Wa
2x

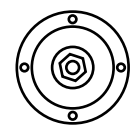

Wb
2x



X
8x

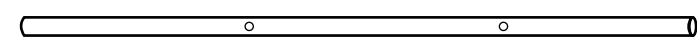

Z1 2x

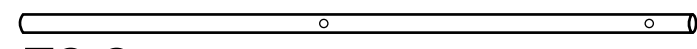

Z2 2x

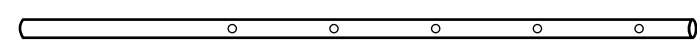

Z3 2x

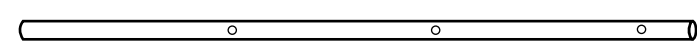

Z4 2x

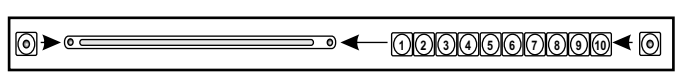

Y 2x

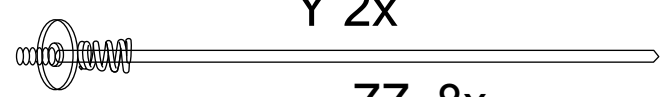

ZZ 8x

1

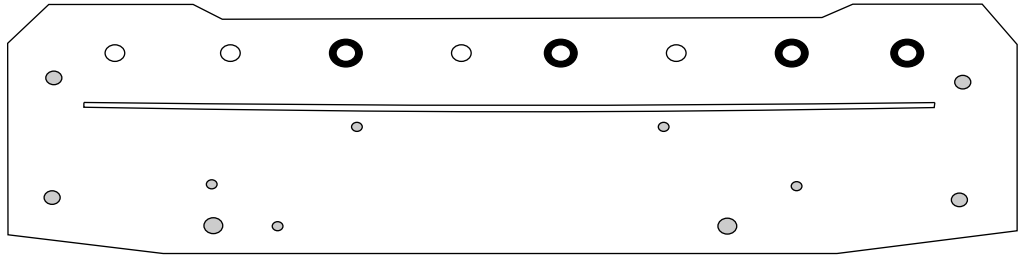

AA 2x

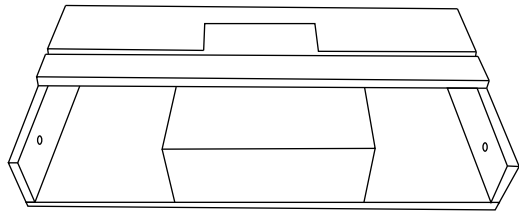

BB 2x

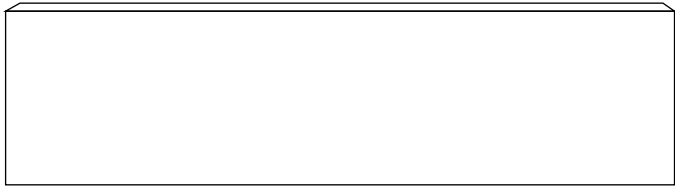

CC 2x



DD 1x

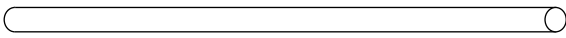

EE 1x

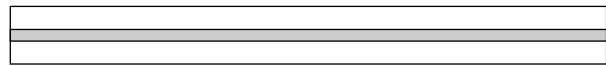

FF 2x

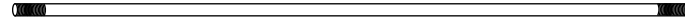

GG 2x

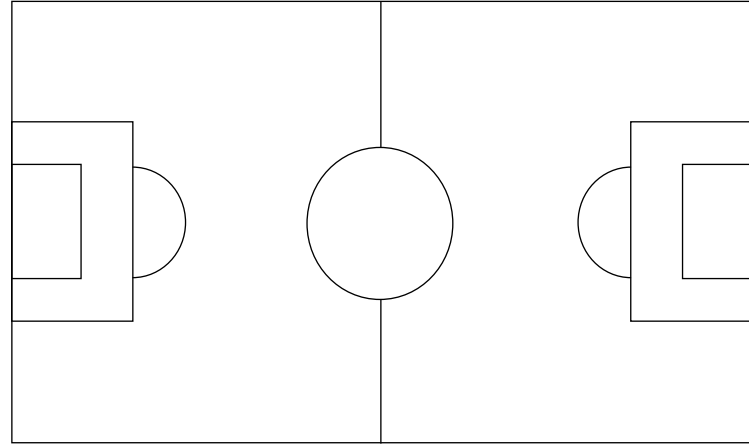

JJ 1x

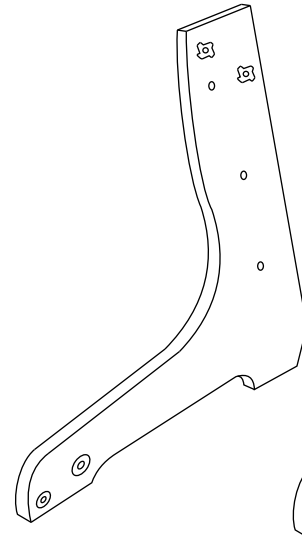

Ka 1x

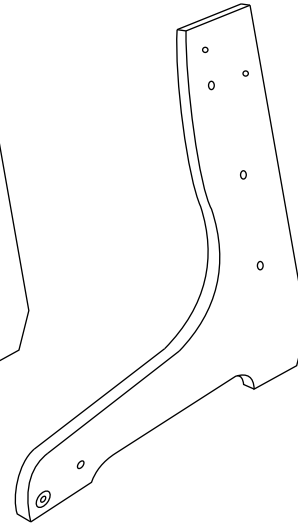

Kb 1x

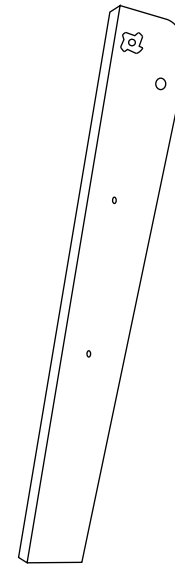

HH 1x

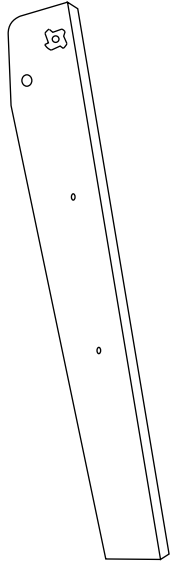

II 1x

3

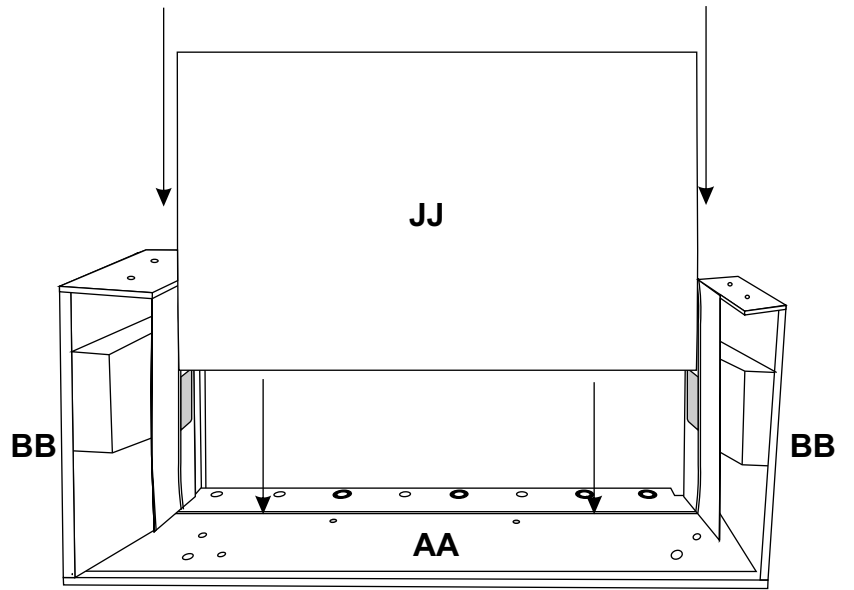
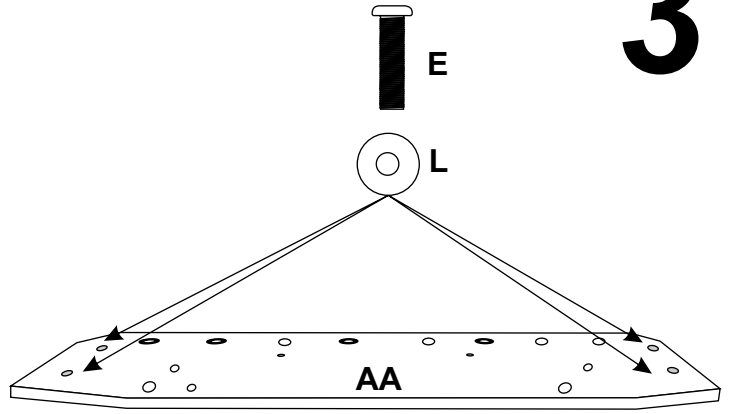
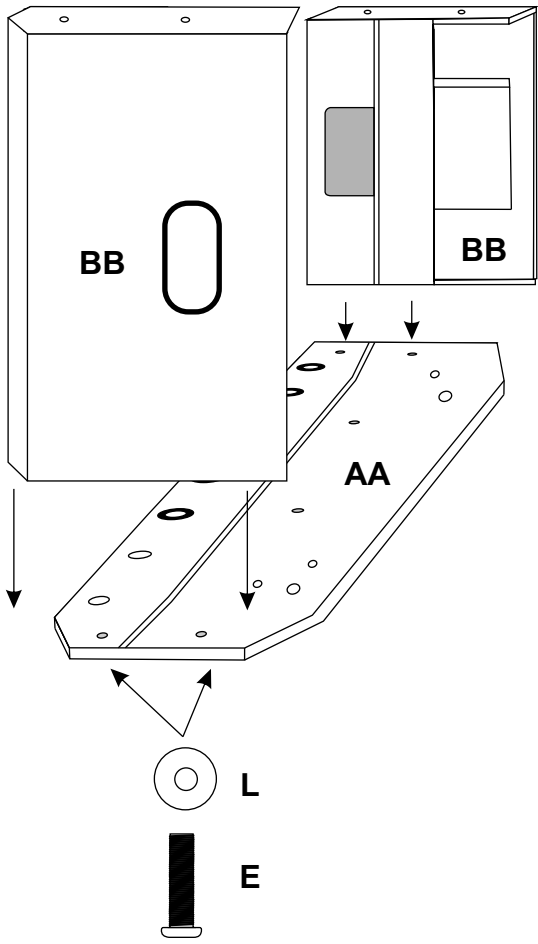

4

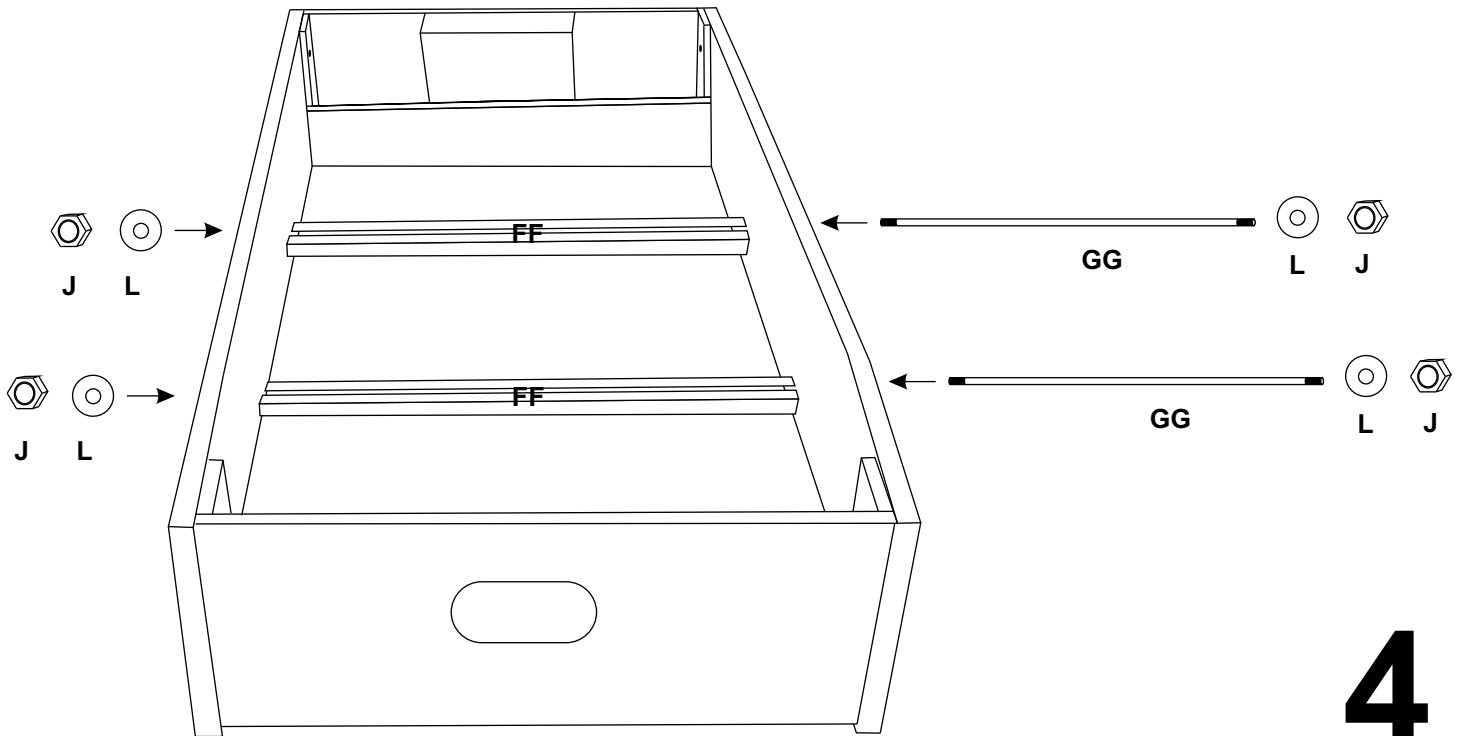

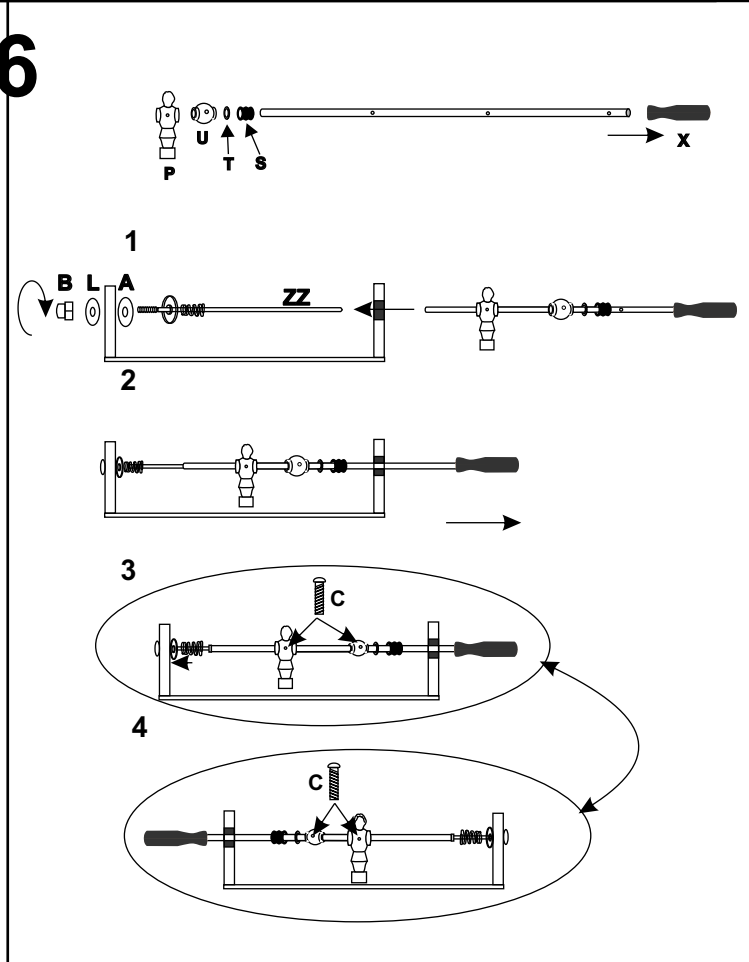
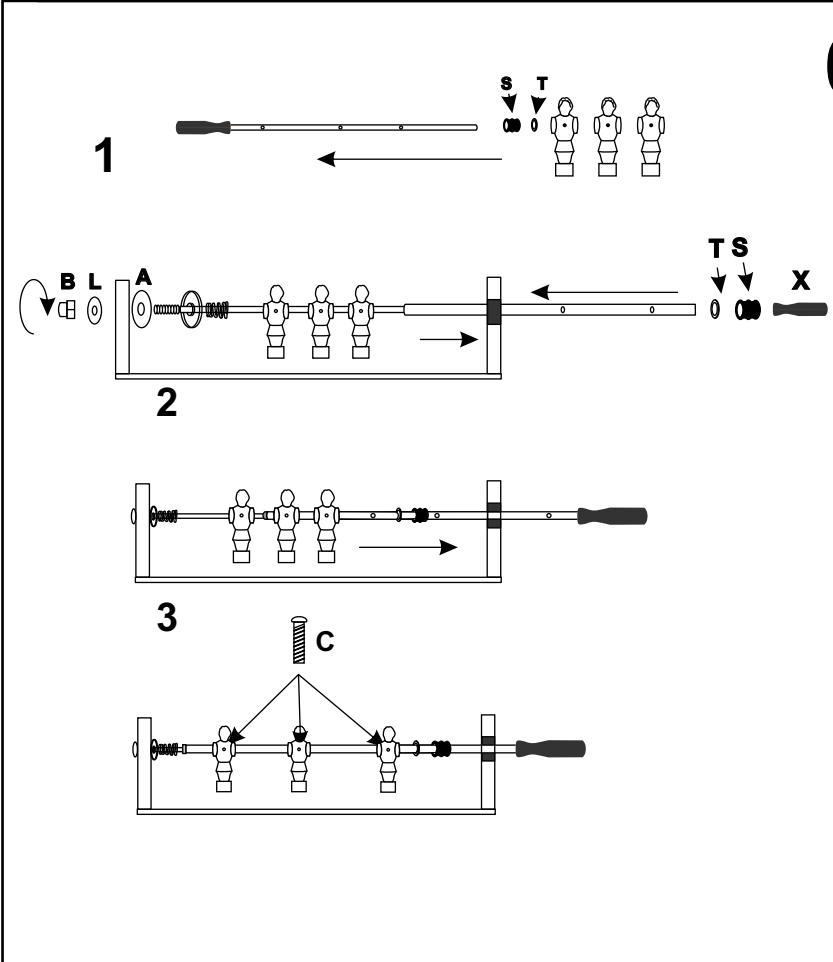
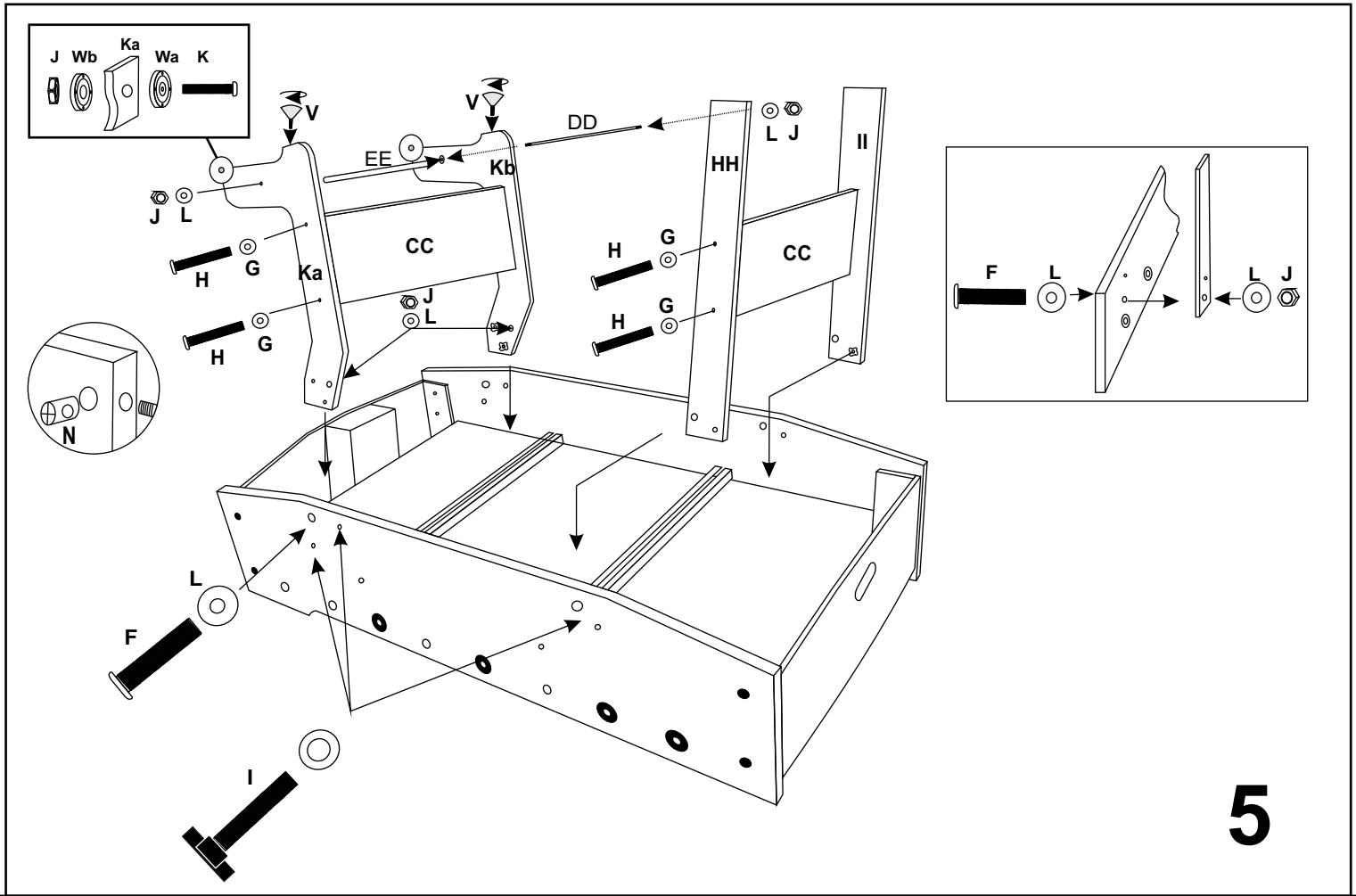

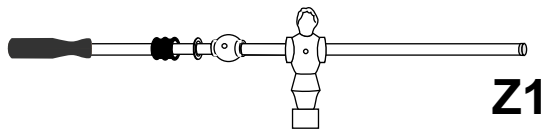

Z1

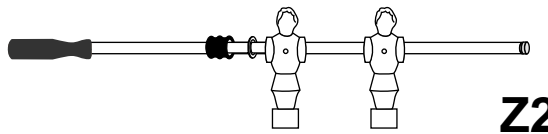

Z2

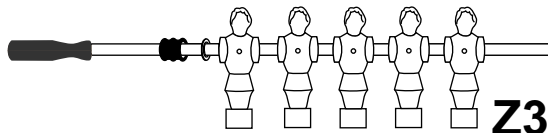

Z3

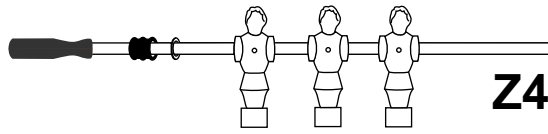

Z4

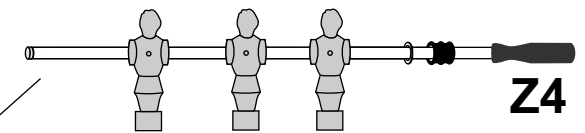
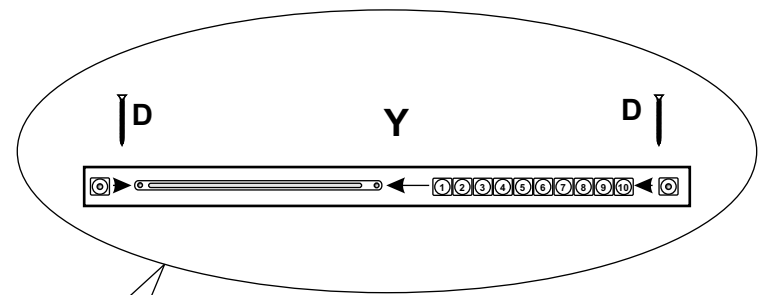

Z4

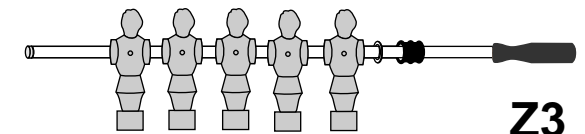

Z3

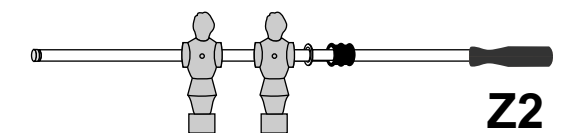

Z2

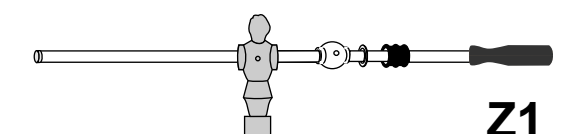

Z1

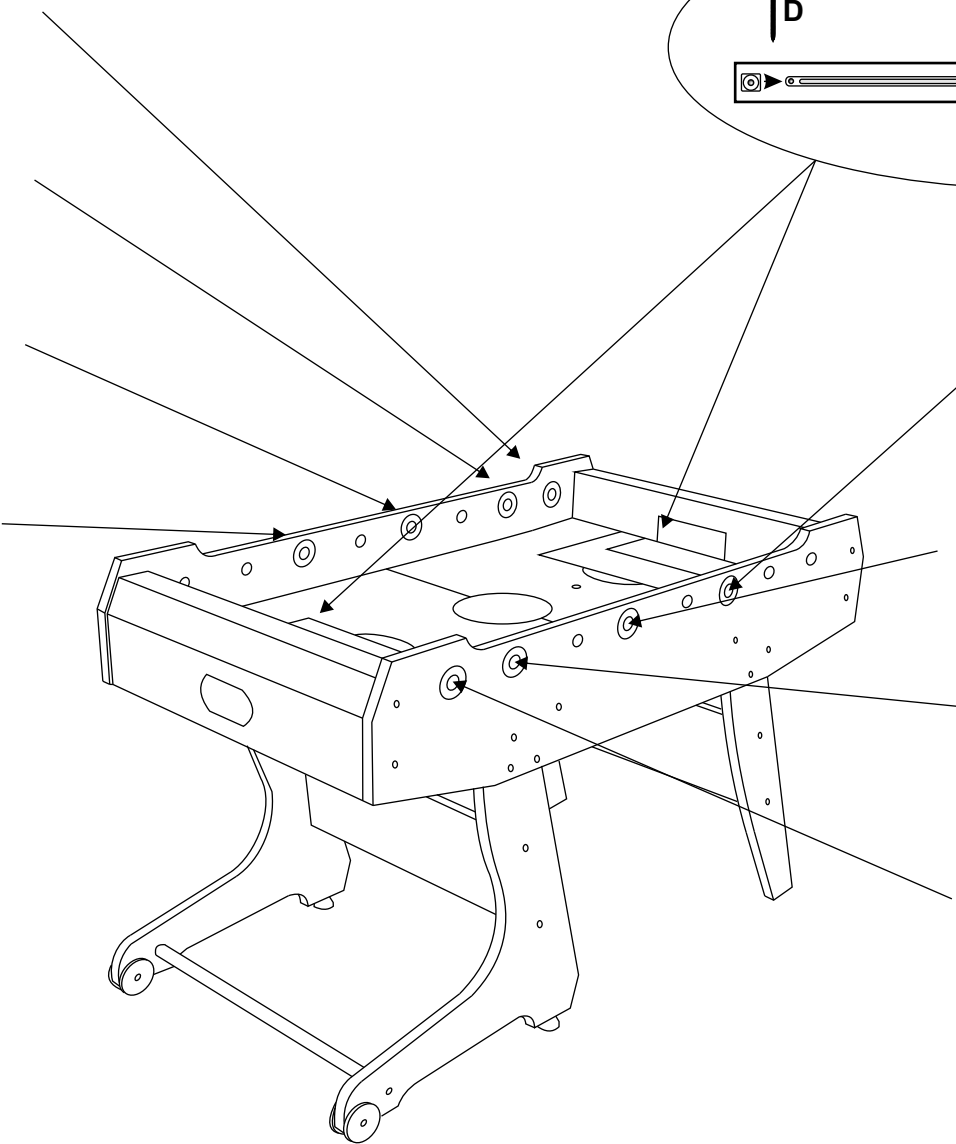

7