



W 6mm

A  
4x



3x12 mm

B  
8x



3.5 x 5mm

D  
48x



Ø8mm

F  
16x



6 x 30mm

G  
12x

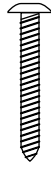

4 x 45mm

H  
8x

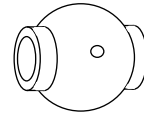

I  
2x



J  
8x



K  
16x

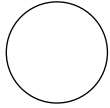

L  
3x

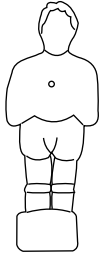

N  
11x

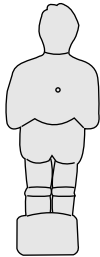

O  
11x



M6 mm

V  
8x



Ø8mm

X  
8x



M6x18mm

Y  
8x



Z  
8x

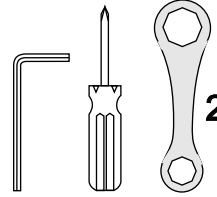

2x

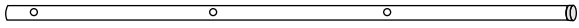

P1 2x



T 8x

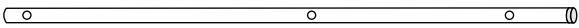

P2 2x



U 4x

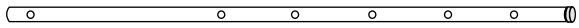

P3 2x

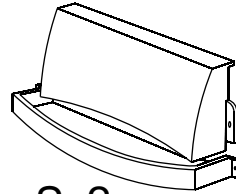

S 2x



Ca 2x

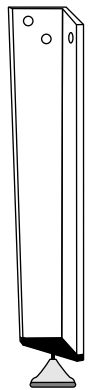

Cb 2x

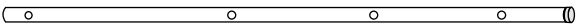

P4 2x



Q 8x



AA 2x

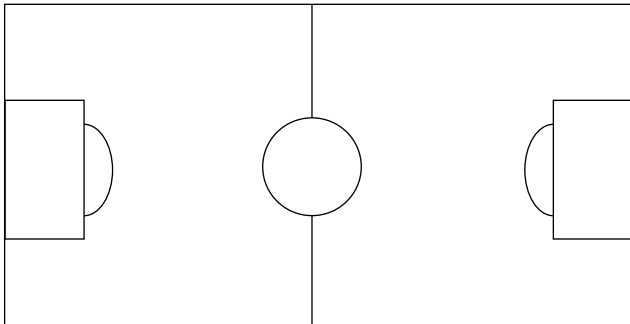

EE 1x

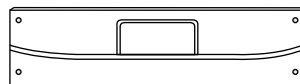

BB 2x

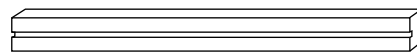







CC 2x



DD 2x



1

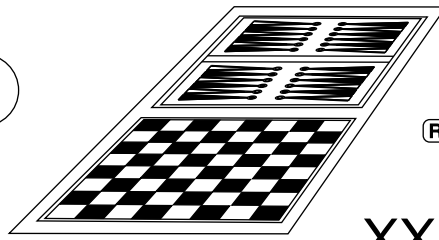

Xa 15x  Xf 10x  Xg 1x   
 Xb 15x    
 Xh 1x  Xi 4x 

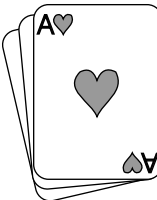

REVERSIBLE

XX 1x

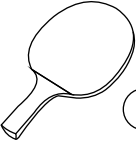
Xd 1x   
 Xe 6x  Xc 1SET 

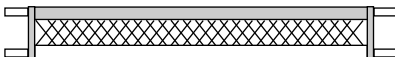
Gc 2x  Gd 3x   
 Ga 2x  Gb 1x 

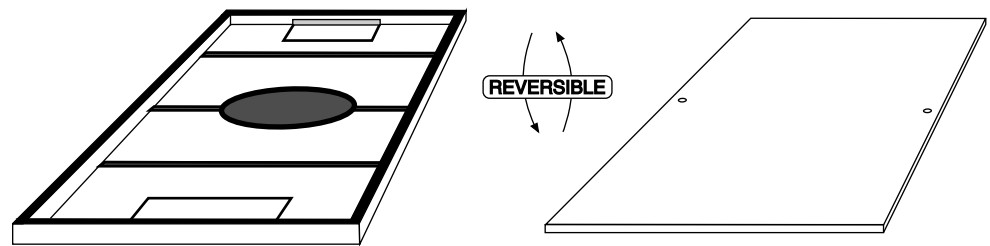

REVERSIBLE

Ge 1x

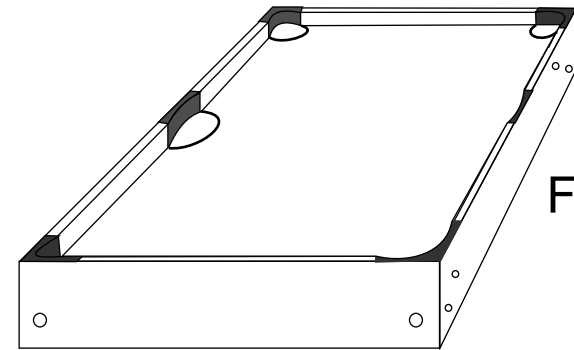

FF 1x

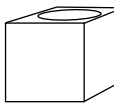
Fd 2x 

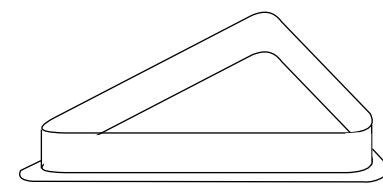

Fc 1x

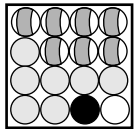
7   Fb 1x

Ib 2x  Ic 2x 

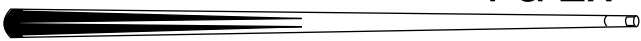
Fa 2x 

2

# 3

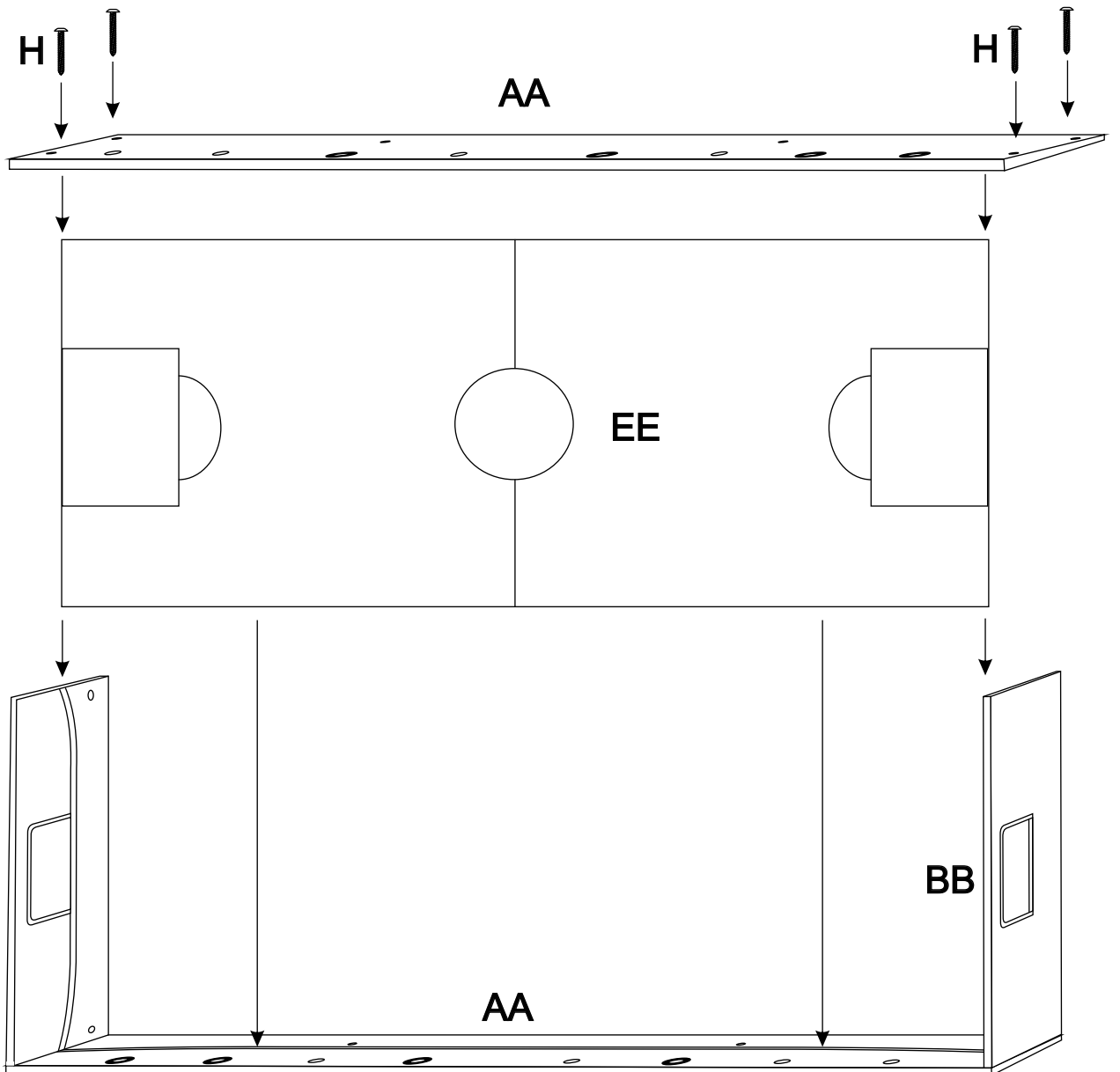
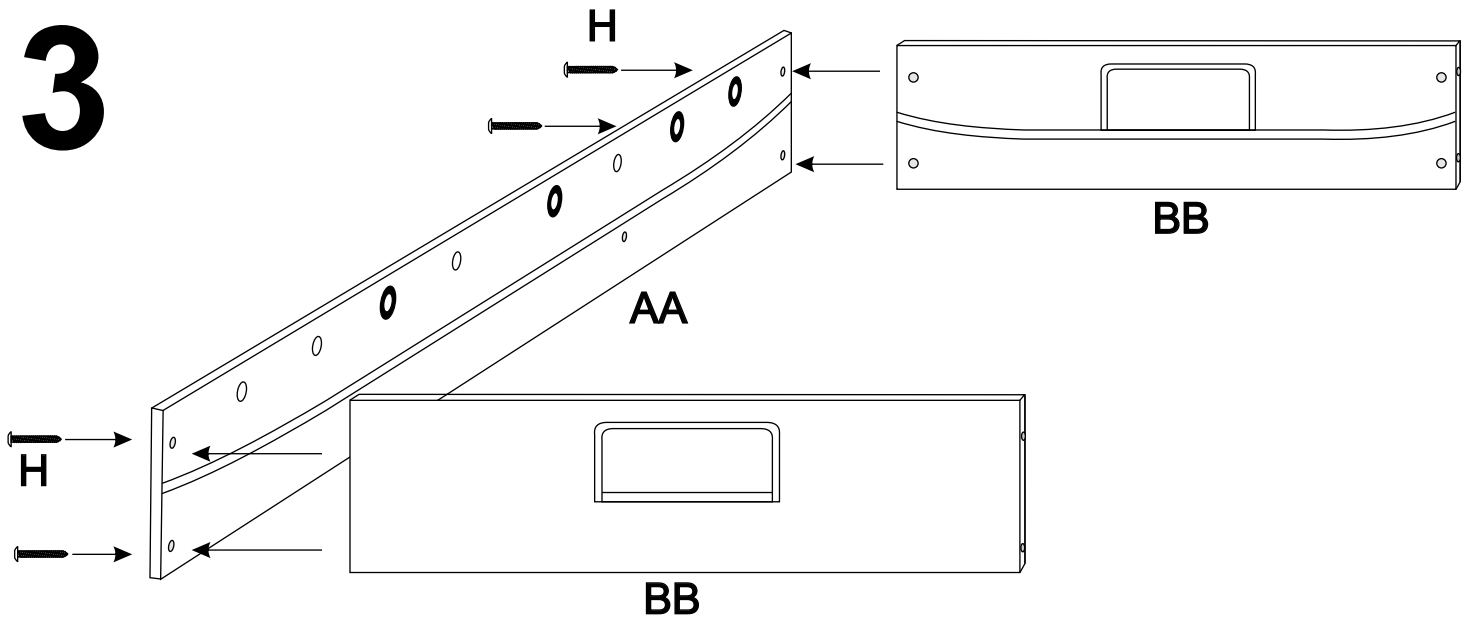

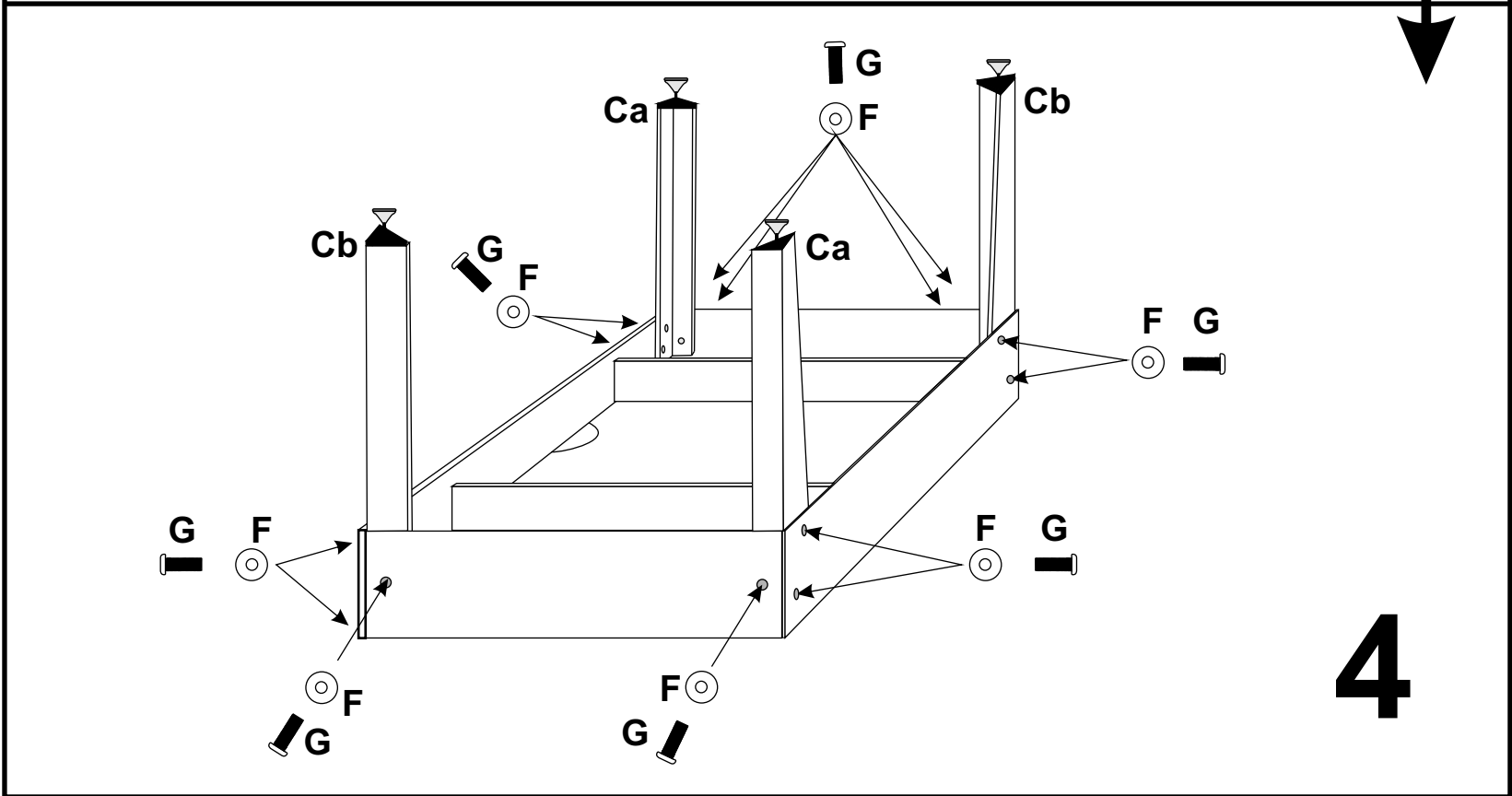
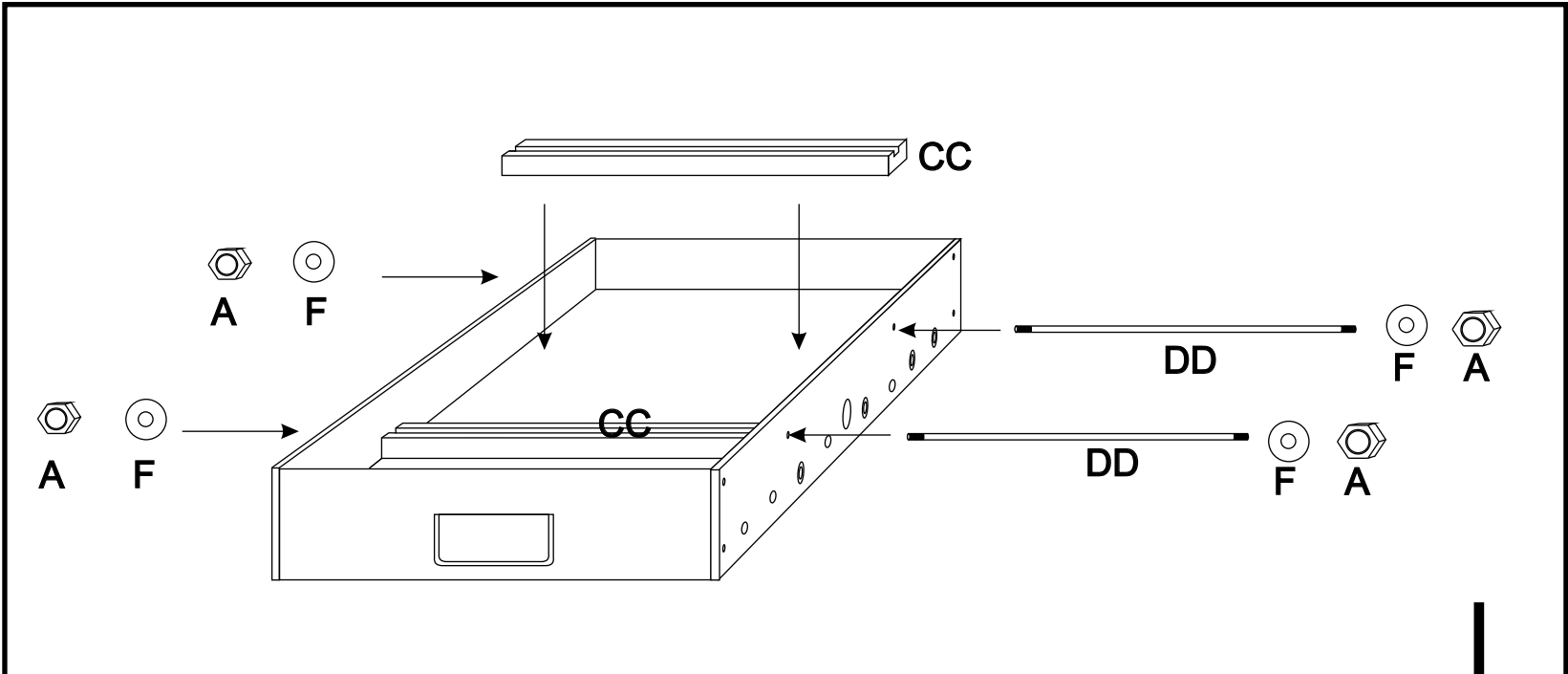

**4**

# 5

1

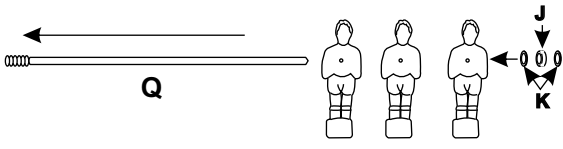

2

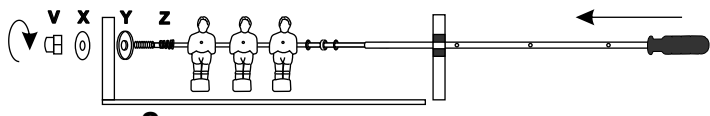

3

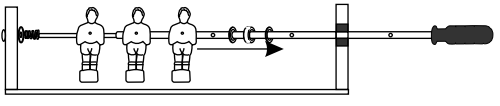

4

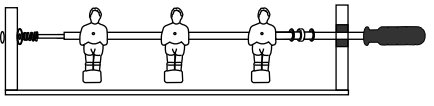

5

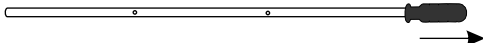
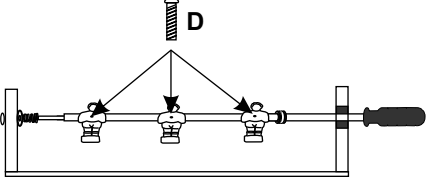

1

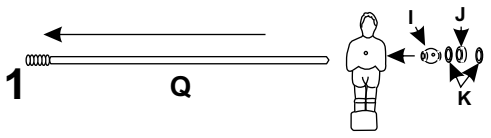

2

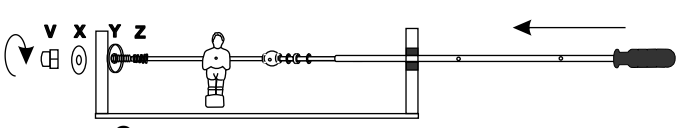

3

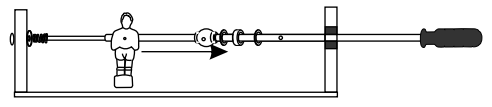

4

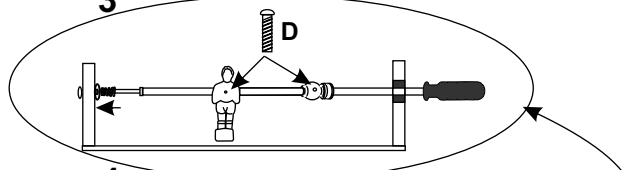

5

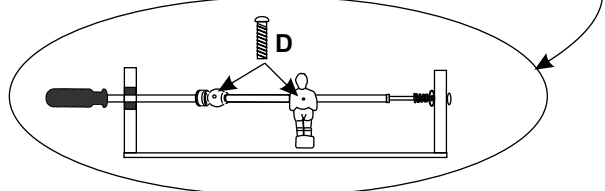

# 6

