

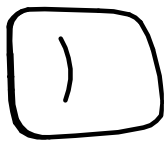

15 min

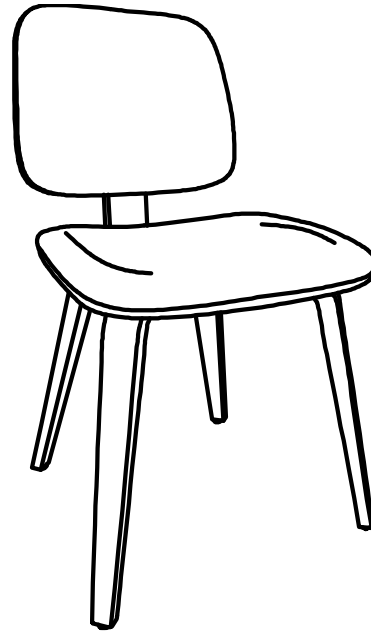

1 pers



A x 1



B x 1

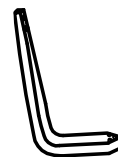

C x 1

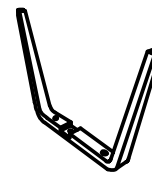

D x 1

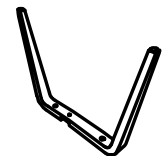

E x 1



M6*40MM+ M6*16*1MM

F x 4



M6*35MM+ M6*16*1MM

G x 3



M6*27MM+ M6*16*1MM

H x 1



M6*22MM+ M6*14*1MM

I x 3



J x 3



M6

K x 1

FR/ Si vous avez des questions sur votre produit, n'hésitez pas à contacter notre service client en remplissant le formulaire de demande sur notre site www.rendezvousdeco.com ou par téléphone au : 04 81 07 37 77.

EN/ If you have any questions about your product, please do not hesitate to contact our service department by filling out the request form on our website www.rendezvousdeco.com or by phone at: +33 (0)4 81 07 37 77.

ES/ Si tiene alguna pregunta sobre su producto, no dude en ponerse en contacto con nuestro departamento de servicio técnico rellenando el formulario de consulta de nuestra página web www.rendezvousdeco.com o llamando al teléfono: +33 (0)4 8 107 37 77.



10 min



1 pers

1

2

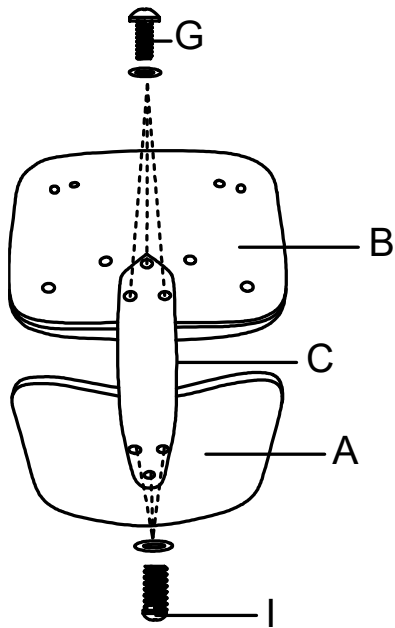

3

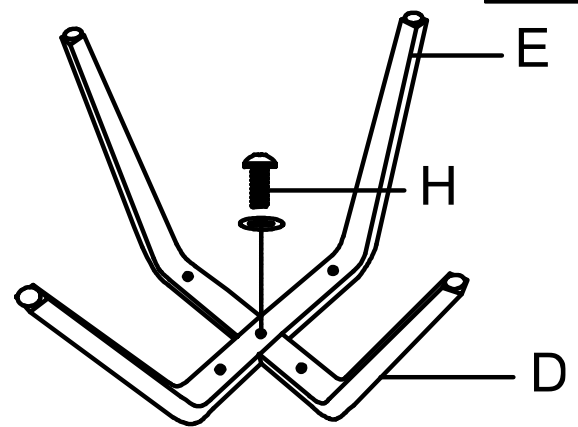

4

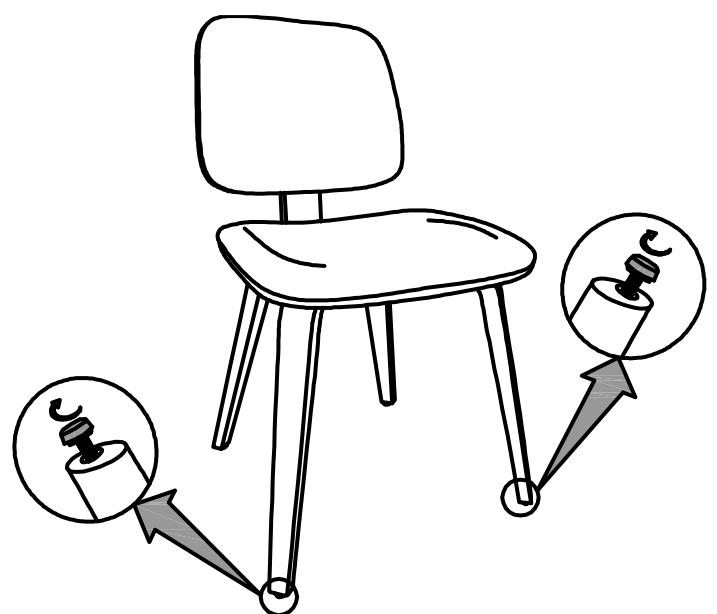
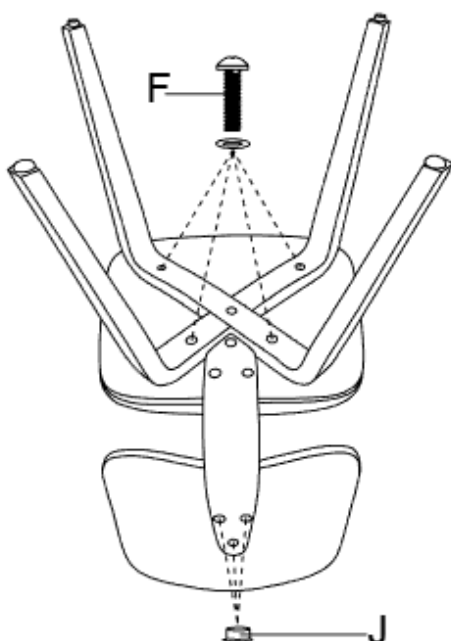
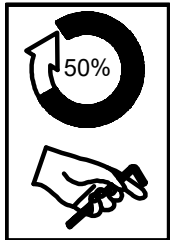

Fixer toutes les vis indiquées à l'étape 2
Fasten All screws indicated in Step 2

Poids max - 130 kg

FR/ Comment entretenir votre meuble ?





Enfin installé chez vous, voici quelques conseils pour en prendre soin !

EN/ How to maintain your furniture?

Finally settled in your home, here are some tips on how to take care of it!

ES/ ¿Cómo mantener sus muebles?

Ahora que ya tiene su propia casa, le damos algunos consejos para cuidarla.

| | FR | EN | ES |
|---|--|---|---|
|  | Ne pas poser d'articles humides ou chauds sur vos assises pour éviter les auréoles. | Do not place wet or hot items on your seats to avoid stains. | No coloque objetos húmedos o calientes en sus asientos para evitar manchas. |
|  | Passer l'aspirateur avec un embout brosse douce pour ne pas érafler la surface. | Vacuum with a soft brush tip to avoid scratching the surface. | Aspirar con una punta de cepillo suave para no rayar la superficie. |
|  | Privilégier un nettoyage doux à l'aide d'un chiffon humide et de l'eau légèrement savonneuse. | Gently clean with a damp cloth and slightly soapy water. | Limpiar suavemente con un paño húmedo y agua ligeramente jabonosa. |
|  | Eviter tout contact entre le tissu et des solutions à base d'alcool, abrasives ou de produits ménagers type Javel. | Avoid any contact between the fabric and alcohol-based solutions, abrasives or household products such as bleach. | Evitar el contacto del tejido con soluciones a base de alcohol, abrasivos o productos domésticos como la lejía. |
|  | Exposées à la lumière, les matières de vos assises peuvent changer de couleur au fil du temps. | When exposed to light, your seating materials can change colour over time. | Al estar expuestos a la luz, los materiales de sus asientos pueden cambiar de color con el tiempo. |



Chez Rendez-Vous Déco, nous croyons en la durabilité pour préserver les ressources. Ainsi chaque jour, nous œuvrons avec nos designers et nos usines à créer des produits issus de savoir-faire locaux, à partir de matériaux de qualité proche de leur lieu d'origine.

Néanmoins, il se peut qu'un jour, votre meuble ne vous donne plus entière satisfaction. Nous vous invitons alors à lui offrir une nouvelle vie en contactant notre partenaire, l'association Maison du tri. Redonner, Réutiliser, Recycler. Ensemble, préservons les ressources.

Pour en savoir plus, scannez ce QR code ou rendez-vous sur : www.maisondutri.fr