



15min



1 pers



Ax1



Bx1



Cx1



Dx1



Fx2



M6 x 25MM

1x4



M6 x 50MM

2x5



M4 x 110MM

3x1



ø8 x 25MM

4x2



1/4"

5x9



ø14,5 x 9MM

6x4



M4 x 25MM

7x4

FR/ Si vous avez des questions sur votre produit, n'hésitez pas à contacter notre service client en remplissant le formulaire de demande sur notre site www.rendezvousdeco.com ou par téléphone au : 04 81 07 37 77.

EN/ If you have any questions about your product, please do not hesitate to contact our service department by filling out the request form on our website www.rendezvousdeco.com or by phone at: +33 (0)4 81 07 37 77.

ES/ Si tiene alguna pregunta sobre su producto, no dude en ponerse en contacto con nuestro departamento de servicio técnico rellenando el formulario de consulta de nuestra página web www.rendezvousdeco.com o llamando al teléfono: +33 (0)4 8 107 37 77.



15min



1 pers

1

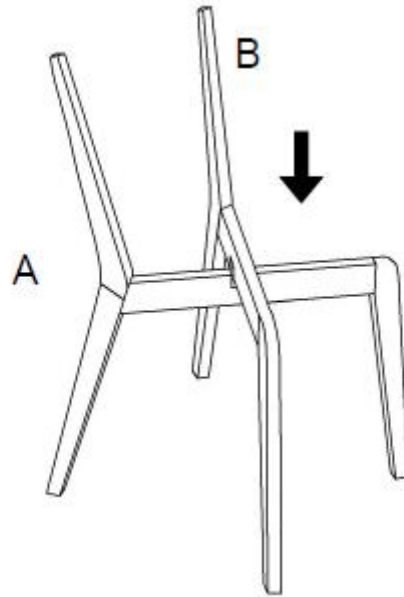

2

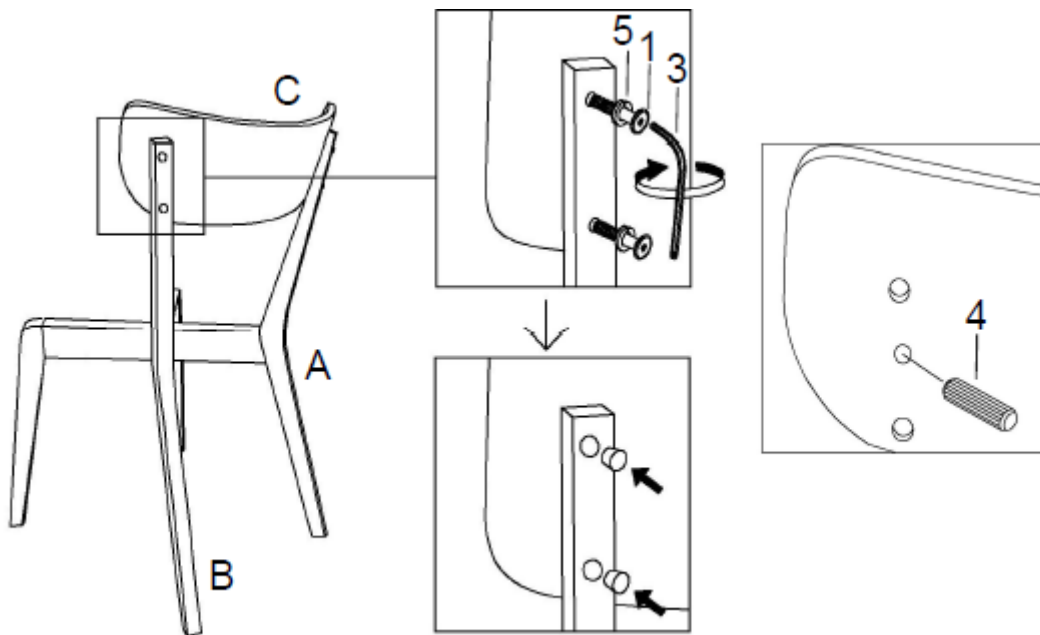



15min



1 pers

3

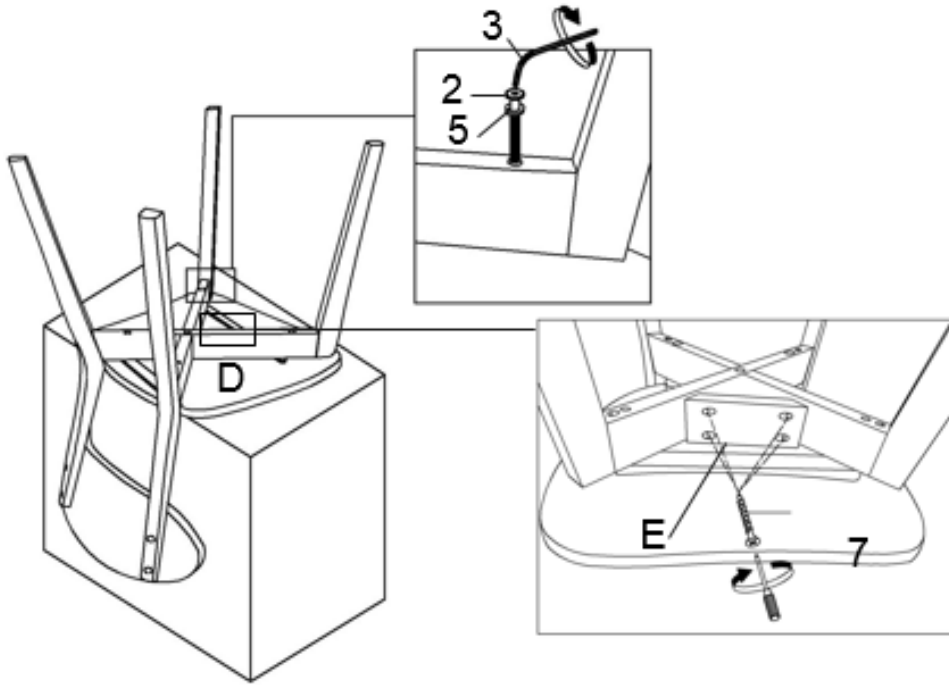

4

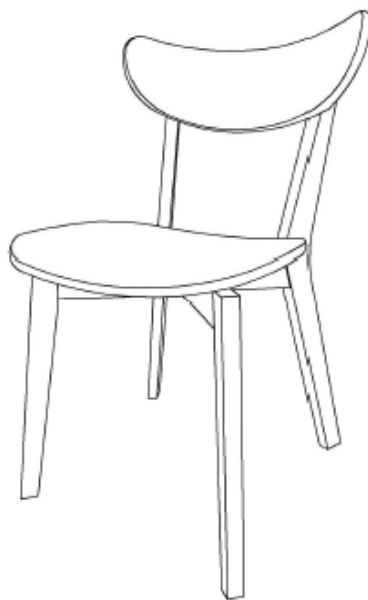

Poids max - 120kg

FR/ Comment entretenir votre meuble ?





Enfin installé chez vous, voici quelques conseils pour en prendre soin !

EN/ How to maintain your furniture?

Finally settled in your home, here are some tips on how to take care of it!

ES/ ¿Cómo mantener sus muebles?

Ahora que ya tiene su propia casa, le damos algunos consejos para cuidarla.

FR	EN	ES
 <p>Ne pas poser d'articles chauds sur vos assises pour éviter les auréoles.</p>	<p>Do not place hot items on your seats to avoid stains.</p>	<p>No coloque objetos calientes en sus asientos para evitar manchas.</p>
 <p>Dépoussiérer régulièrement la surface de votre meuble avec un aspirateur ou avec l'aide d'un chiffon en microfibre.</p>	<p>Regularly dust the surface of your furniture with a vacuum cleaner or with a microfiber cloth.</p>	<p>Limpie regularmente la superficie de su mueble con una aspiradora o con un paño de microfibra.</p>
 <p>Nettoyer le bois de votre meuble à l'aide d'un chiffon légèrement humidifié avec du savon de Marseille.</p>	<p>Clean the wood of your furniture with a cloth slightly moistened with natural soap.</p>	<p>Limpie la madera de sus muebles con un paño ligeramente humedecido con jabón natural.</p>
 <p>Eviter tout contact entre le tissu et des solutions à base d'alcool, abrasives ou de produits ménagers type javel</p>	<p>Avoid any contact between the fabric and alcohol-based solutions, abrasives or household products such as bleach.</p>	<p>Evitar el contacto del tejido con soluciones a base de alcohol, abrasivos o productos domésticos como la lejía.</p>
 <p>Exposées à la lumière, les matières de vos assises peuvent changer de couleur au fil du temps</p>	<p>When exposed to light, your seating materials can change colour over time.</p>	<p>Al estar expuestos a la luz, los materiales de sus asientos pueden cambiar de color con el tiempo</p>



Chez Rendez-Vous Déco, nous croyons en la durabilité pour préserver les ressources. Ainsi chaque jour, nous œuvrons avec nos designers et nos usines à créer des produits issus de savoir-faire locaux, à partir de matériaux de qualité proche de leur lieu d'origine.

Néanmoins, il se peut qu'un jour, votre meuble ne vous donne plus entière satisfaction. Nous vous invitons alors à lui offrir une nouvelle vie en contactant notre partenaire, l'association Maison du tri. Redonner, Réutiliser, Recycler. Ensemble, préservons les ressources.

Pour en savoir plus, scannez ce QR code ou rendez-vous sur : www.maisondutri.fr